



## PUBLIC NOTICE D01-197-23

### PROPOSED CONSTRUCTION OF THE NEW AMTRAK BRIDGE ACROSS CONNECTICUT RIVER, BETWEEN OLD SAYBROOK AND OLD LYME, CONNECTICUT.

All interested parties are notified that the Commander, First Coast Guard District, has received application materials from the National Railroad Passenger Corporation (AMTRAK) for a U.S. Coast Guard (USCG) Bridge Permit for approval of the location and plans for construction of a replacement bascule bridge over a navigable waterway of the United States. The purpose of the project is to replace the Connecticut River Bridge, which became operational in 1907 and is nearing the end of its useful life. The proposed bridge provides increased vertical and horizontal clearances.

**WATERWAY AND LOCATION:** Connecticut River, mile 3.4 between Old Saybrook, Middlesex County, CT and Old Lyme, New London County, CT.

**CHARACTER OF WORK:** Amtrak proposes to replace the existing movable bascule bridge, with a new bascule bridge approximately 52 feet south of the existing bridge. The replacement bridge will contain a two-track, electrified railroad movable bridge, approach spans and at-grade approaches that tie into the existing railroad. The new structure will increase the horizontal clearance at the bridge crossing from an existing posted width of 139-ft to a proposed width of 150-ft. The fender line at the east face of the proposed channel will be shifted approximately 16.5-ft to the west relative to the existing edge of posted channel. The project will improve the reliability of passenger and freight rail operations along the Northeast Corridor as well as navigation on the Connecticut River. To better accommodate vessel traffic in the summer season, the existing bridge remains in the open to navigation position and closes only for train passage.

The existing bridge superstructure, rail facilities and timber fender system will be removed in their entirety. Existing Pier 5 that falls along the edge of the new navigation channel will be removed in its entirety, including timber piling foundations. River Piers 1 through 4, 8 and 9 will be removed down to specific elevations below the channel bed. River Piers 6 and 7 will be left in place for movable bridge pier protection and as historic remnants of the existing bridge. The east and west abutments at the shoreline will be left in place.

*Temporary Conditions:* During construction, aerial cables will be necessary to provide temporary power and signal connectivity across the channel and there will be a resulting temporary vertical clearance restriction of 102-ft. The temporary impact to vertical clearance is anticipated to extend for the full duration of the construction project. The horizontal clearance will have periods of temporary impacts including short duration full closures and extended periods of reduced clearance. The minimum temporary channel width is anticipated to be 129-ft wide.

The minimum navigation clearances for the final proposed structure are presented in the table below:

**MINIMUM NAVIGATIONAL CLEARANCES:**

	<b>Vertical Clearance Closed (MHW)</b>	<b>Vertical Clearance Open (MHW)</b>	<b>Horizontal Clearance</b>
<b>Existing Bridge</b>	19 ft	Unlimited across 71 ft of channel width	139 ft
<b>Proposed Bridge</b>	24 ft	Unlimited across 90 ft of channel width	150 ft

Datum is NAVD88.

**ENVIRONMENTAL CONSIDERATION:** The Federal Railroad Administration (FRA) is the lead federal agency for satisfying the requirements of the National Environmental Policy Act (NEPA) for the replacement of the Amtrak Connecticut River Bridge. The lead federal agency acts on behalf of the USCG for environmental laws applicable to this project. On May 2014, the FRA issued an Environmental Assessment (EA) and Section 4(f) evaluation. On November 2017, the FRA issued a Finding of No Significant Impact (FONSI). The USCG requested a NEPA re-evaluation due to the time lag.

The USCG plans to adopt the FRA EA and issue a USCG Finding of No Significant Impact for this project subject to information received from public comments. The environmental documents may be received electronically for review by emailing [Stephanie.E.Lopez@uscg.mil](mailto:Stephanie.E.Lopez@uscg.mil).

Amtrak will submit the Final Joint Permit Application for CT DEEP Section 401 Water Quality Certification & USACE Section 404 Clean Water Act, and Section 10 Rivers & Harbors Act for approval from CT DEEP & USACE.

The proposed bridge is in the flood plain. The low steel elevation is 25.71-ft. The FEMA 100-yr Base Flood Elevations (NAVD 88) are as follows:

- Connecticut River West Side, Upstream Side Zone AE 11-ft
- Connecticut River West Side, Downstream Side Zone VE 15-ft
- Connecticut River East Side, Upstream Side Zone AE 10-ft
- Connecticut River East Side, Downstream Side Zone VE 14-ft

**SOLICITATION OF COMMENTS:**

Interested parties are requested to comment on the proposed navigation clearances, impacts to navigation, placement of a bridge protective system and other navigational safety issues,

including need for clearance gauges and extent of nighttime navigation to determine the need for bridge lighting.

We will forward comments of an environmental nature such as those regarding wildlife refuges, water-fowl refuges, public parks, historic sites, wetlands, floodplain issues, air, water quality, etc. to the Federal Railroad Administration. Comments will be received for the record by email to Stephanie E. Lopez, Bridge Management Specialist, at: [D1Boston-Bridges-PublicNotices@uscg.mil](mailto:D1Boston-Bridges-PublicNotices@uscg.mil) or at the address noted in the header of this notice through June 26, 2023.

It is requested that this information be brought to the attention of any person having an interest in this who may not have received a copy of this public notice announcement.

Map of location and plans attached.

D. A. Fisher  
Bridge Program Manager  
U.S. Coast Guard  
By direction



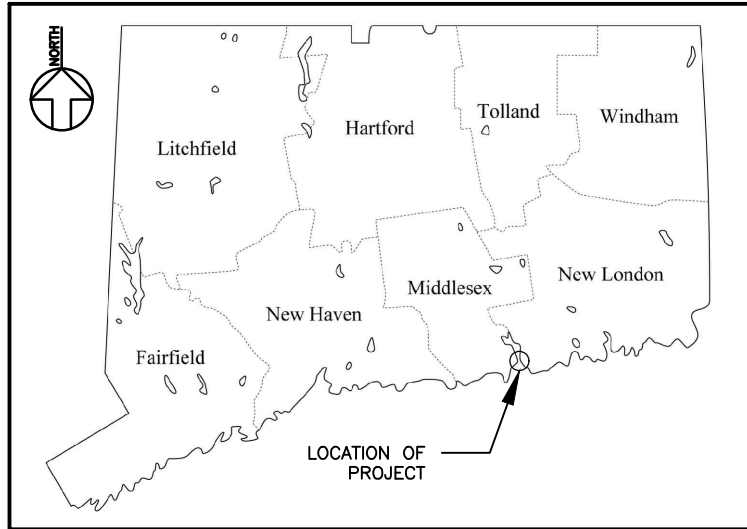

**VICINITY MAP**

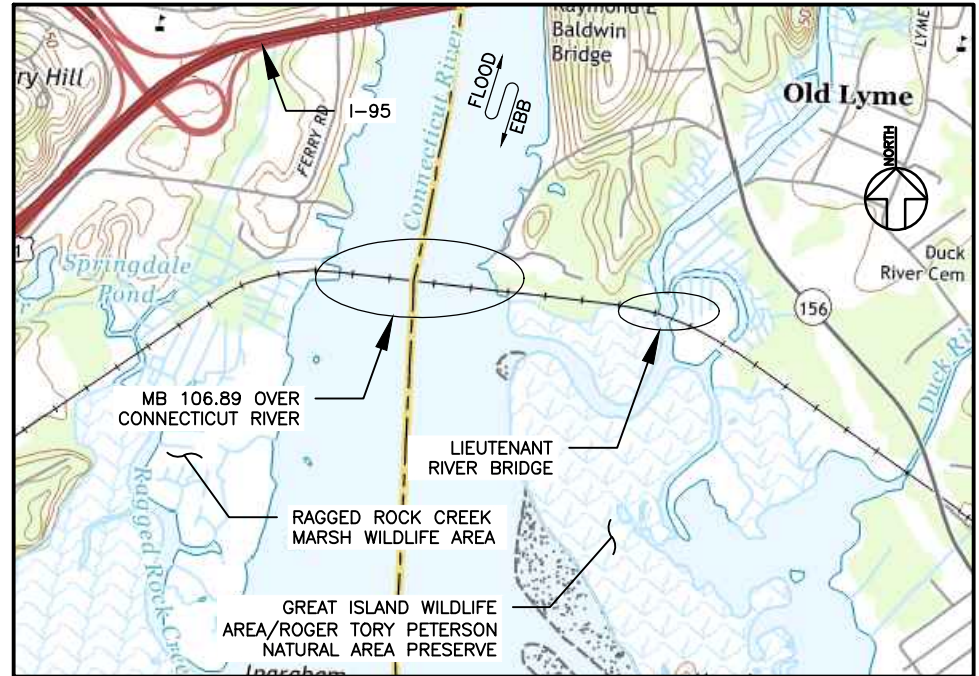
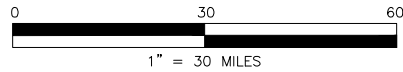

**LOCATION MAP**



ACCORDING TO THE NOAA MARINE PROTECTED AREA INVENTORY, MARINE PROTECTED AREAS IN OR ADJACENT TO THE PROPOSED PROJECT SITE INCLUDE THE FOLLOWING:

- RAGGED ROCK CREEK MARSH WILDLIFE AREA
- GREAT ISLAND WILDLIFE AREA/ROGER TORY PETERSON NATURAL AREA PRESERVE

MHW EL. = +1.71  
 MLW EL. = -1.48  
 100 YEAR FLOOD = +15.00  
 500 YEAR FLOOD = +15.90  
 DATUM: NAVD 1988

NOTE: CONCEPTUAL PLANS USED TO OBTAIN U.S. COAST GUARD BRIDGE PERMIT

HARDESTY & HANOVER, LLC 1501 BROADWAY, NEW YORK, NY 10036  STEVEN DAVID HARLACKER CONNECTICUT PROFESSIONAL ENGINEER LICENSE NO. PEN.0022034 DATE: 08/04/2020		<b>NATIONAL RAILROAD PASSENGER CORPORATION (AMTRAK)</b>  REPLACEMENT OF CONN. BRIDGE NO. 106.89 OVER THE CONNECTICUT RIVER CONNECTICUT RIVER MP 3.4 TOWN OF OLD SAYBROOK, MIDDLESEX COUNTY & TOWN OF OLD LYME, NEW LONDON COUNTY STATE OF CONNECTICUT  CONSULTANT: HARDESTY & HANOVER LLC APPLICATION BY: NATIONAL RAILROAD PASSENGER CORPORATION SHEET 1 OF 7 DATE: 08/04/2020	
REVISION	BY	C'K'D	DATE

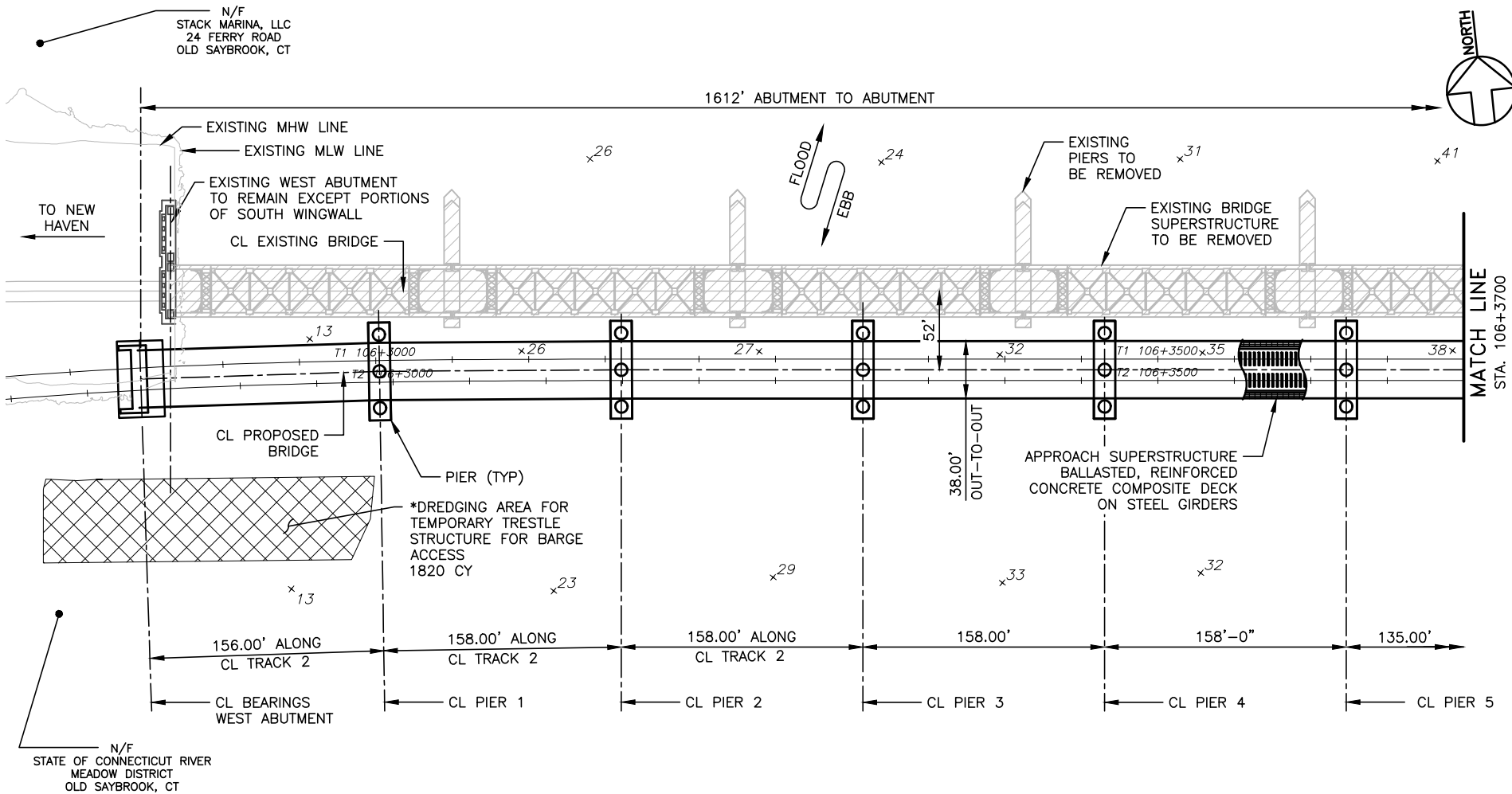

**PARTIAL PLAN – PROPOSED AMTRAK CONN BRIDGE OVER CONNECTICUT RIVER, WEST ABUTMENT TO PIER 5**

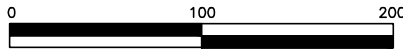

× = WATER DEPTH BELOW MHW

1" = 100'

NOTE: CONCEPTUAL PLANS USED TO OBTAIN U.S. COAST GUARD BRIDGE PERMIT

**NOTES:**

- UNLESS MARKED EXISTING, ALL ELEMENTS SHOWN ON THIS DRAWING REFLECT PROPOSED CONDITIONS.

MHW EL. = +1.71  
 MLW EL. = -1.48  
 100 YEAR FLOOD = +15.00  
 500 YEAR FLOOD = +15.90  
 DATUM: NAVD 1988



HARDESTY & HANOVER, LLC  
 1501 BROADWAY, NEW YORK, NY 10036

*Steven David Harlacker*  
 STEVEN DAVID HARLACKER  
 CONNECTICUT PROFESSIONAL ENGINEER  
 LICENSE NO. PEN.0022034  
 DATE: 08/04/2020

REVISION	BY	C'K'D	DATE

**NATIONAL RAILROAD PASSENGER CORPORATION (AMTRAK)**

REPLACEMENT OF CONN. BRIDGE NO. 106.89  
 OVER THE CONNECTICUT RIVER  
 CONNECTICUT RIVER MP 3.4  
 TOWN OF OLD SAYBROOK, MIDDLESEX COUNTY &  
 TOWN OF OLD LYME, NEW LONDON COUNTY  
 STATE OF CONNECTICUT

CONSULTANT: HARDESTY & HANOVER LLC  
 APPLICATION BY:  
 NATIONAL RAILROAD PASSENGER CORPORATION

SHEET 2 OF 7

DATE: 08/04/2020

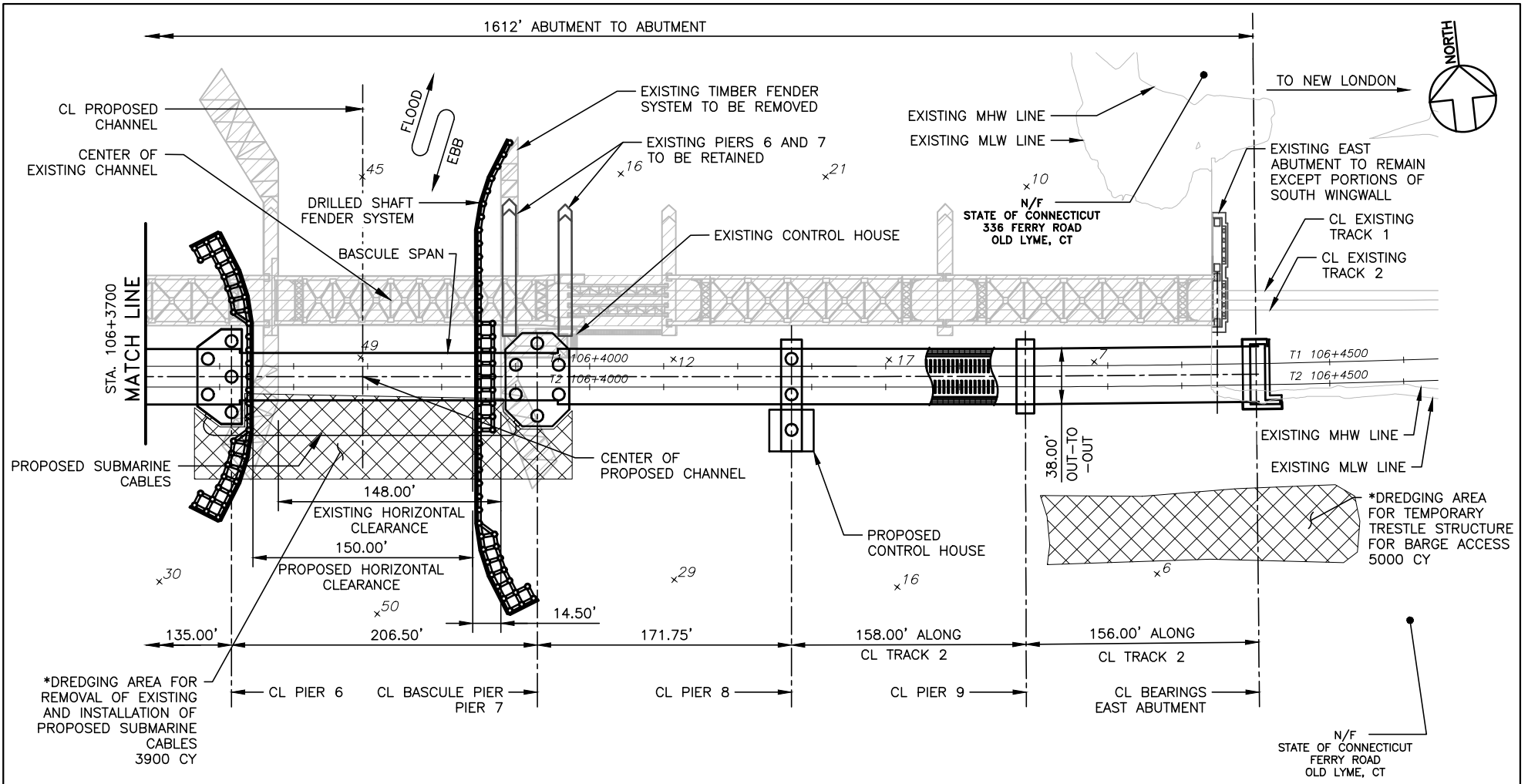

**PARTIAL PLAN – PROPOSED AMTRAK CONN BRIDGE OVER CONNECTICUT RIVER, PIER 6 TO EAST ABUTMENT**



× = WATER DEPTH BELOW MHW

**NOTES:**

- UNLESS MARKED EXISTING, ALL ELEMENTS SHOWN ON THIS DRAWING REFLECT PROPOSED CONDITIONS.

MHW EL. = +1.71  
 MLW EL. = -1.48  
 100 YEAR FLOOD = +15.00  
 500 YEAR FLOOD = +15.90  
 DATUM: NAVD 1988



NOTE: CONCEPTUAL PLANS USED TO OBTAIN U.S. COAST GUARD BRIDGE PERMIT

<b>HARDESTY &amp; HANOVER, LLC</b> 1501 BROADWAY, NEW YORK, NY 10036  <b>STEVEN DAVID HARLACKER</b> CONNECTICUT PROFESSIONAL ENGINEER LICENSE NO. PEN.0022034 DATE: 08/04/2020		<b>NATIONAL RAILROAD PASSENGER CORPORATION (AMTRAK)</b>  REPLACEMENT OF CONN. BRIDGE NO. 106.89 OVER THE CONNECTICUT RIVER CONNECTICUT RIVER MP 3.4 TOWN OF OLD SAYBROOK, MIDDLESEX COUNTY & TOWN OF OLD LYME, NEW LONDON COUNTY STATE OF CONNECTICUT  CONSULTANT: HARDESTY & HANOVER LLC APPLICATION BY: NATIONAL RAILROAD PASSENGER CORPORATION SHEET 3 OF 7	
REVISION	BY	C'K'D	DATE

DATE: 08/04/2020

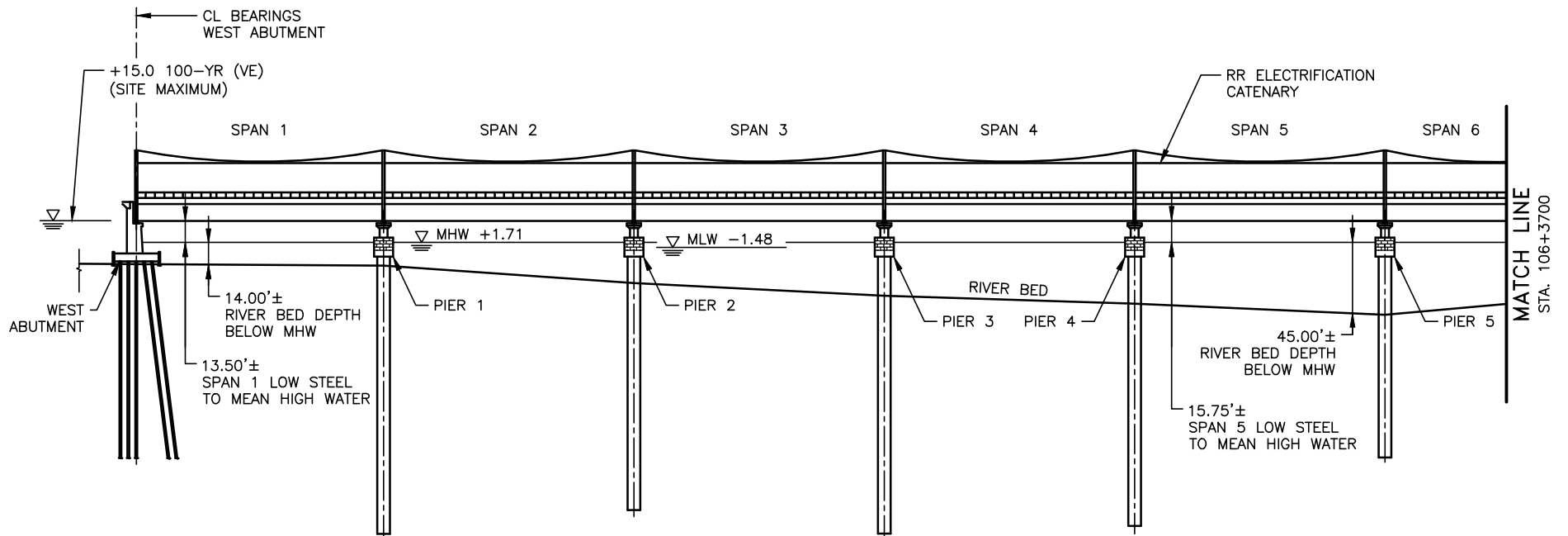

PARTIAL ELEVATION – PROPOSED AMTRAK CONN BRIDGE OVER CONNECTICUT RIVER, WEST ABUTMENT TO PIER 5

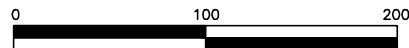

1" = 100'

NOTE: CONCEPTUAL PLANS USED TO OBTAIN U.S. COAST GUARD BRIDGE PERMIT

NOTES:

- UNLESS MARKED EXISTING, ALL ELEMENTS SHOWN ON THIS DRAWING REFLECT PROPOSED CONDITIONS.

MHW EL. = +1.71  
 MLW EL. = -1.48  
 100 YEAR FLOOD = +15.00  
 500 YEAR FLOOD = +15.90  
 DATUM: NAVD 1988



HARDESTY & HANOVER, LLC  
 1501 BROADWAY, NEW YORK, NY 10036

*Steven D. Harlacker*  
 STEVEN DAVID HARLACKER  
 CONNECTICUT PROFESSIONAL ENGINEER  
 LICENSE NO. PEN.0022034  
 DATE: 08/04/2020

REVISION	BY	C'K'D	DATE

NATIONAL RAILROAD PASSENGER CORPORATION (AMTRAK)

REPLACEMENT OF CONN. BRIDGE NO. 106.89  
 OVER THE CONNECTICUT RIVER  
 CONNECTICUT RIVER MP 3.4  
 TOWN OF OLD SAYBROOK, MIDDLESEX COUNTY &  
 TOWN OF OLD LYME, NEW LONDON COUNTY  
 STATE OF CONNECTICUT

CONSULTANT: HARDESTY & HANOVER LLC  
 APPLICATION BY:  
 NATIONAL RAILROAD PASSENGER CORPORATION

SHEET 4 OF 7 DATE: 08/04/2020



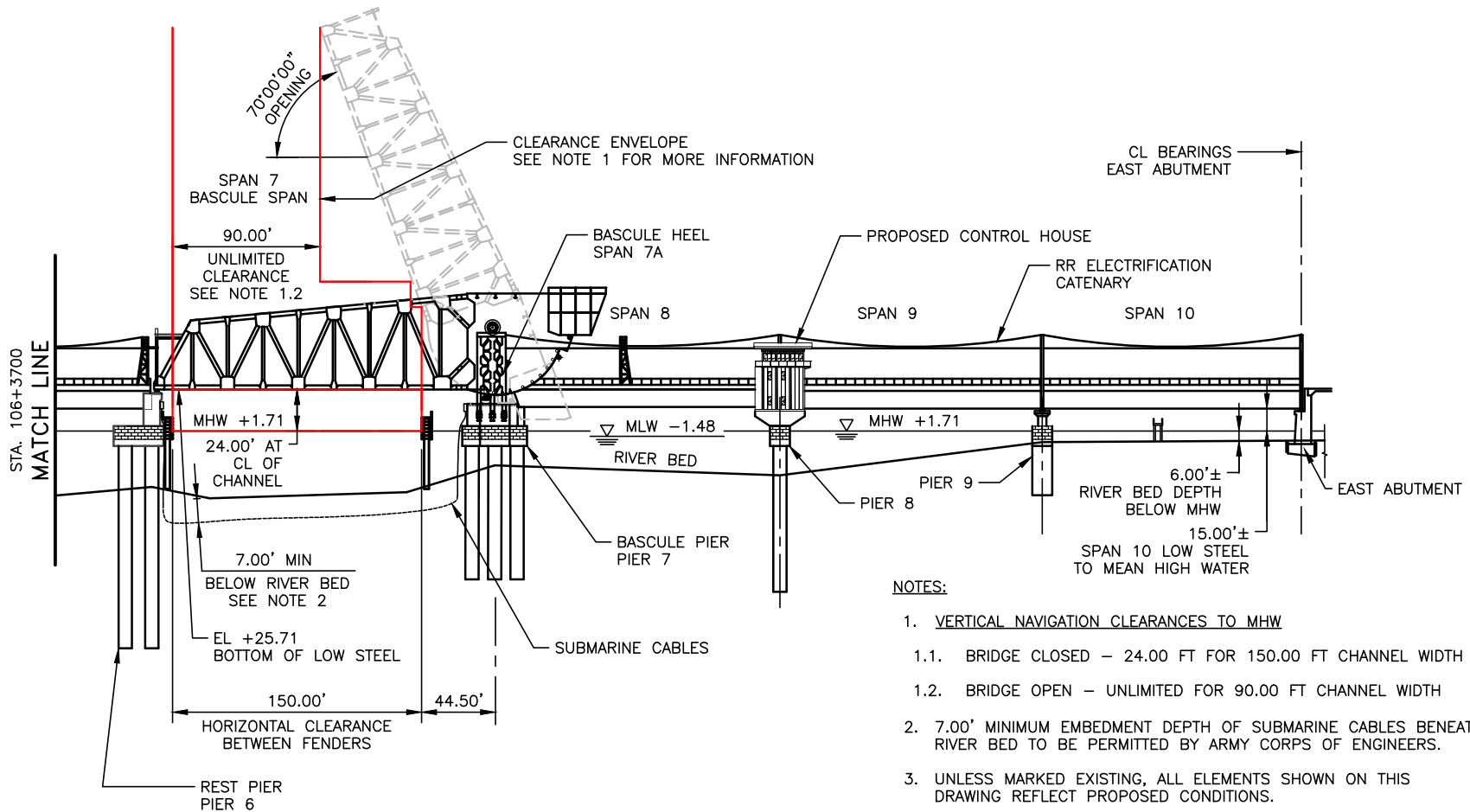

- NOTES:**
- VERTICAL NAVIGATION CLEARANCES TO MHW
    - BRIDGE CLOSED – 24.00 FT FOR 150.00 FT CHANNEL WIDTH
    - BRIDGE OPEN – UNLIMITED FOR 90.00 FT CHANNEL WIDTH
  - 7.00' MINIMUM EMBEDMENT DEPTH OF SUBMARINE CABLES BENEATH RIVER BED TO BE PERMITTED BY ARMY CORPS OF ENGINEERS.
  - UNLESS MARKED EXISTING, ALL ELEMENTS SHOWN ON THIS DRAWING REFLECT PROPOSED CONDITIONS.

**PARTIAL ELEVATION – PROPOSED AMTRAK CONN BRIDGE OVER CONNECTICUT RIVER, PIER 6 TO EAST ABUTMENT**

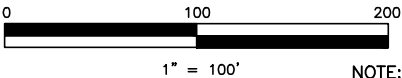

NOTE: CONCEPTUAL PLANS USED TO OBTAIN U.S. COAST GUARD BRIDGE PERMIT

MHW EL. = +1.71  
 MLW EL. = -1.48  
 100 YEAR FLOOD = +15.00  
 500 YEAR FLOOD = +15.90  
 DATUM: NAVD 1988



HARDESTY & HANOVER, LLC 1501 BROADWAY, NEW YORK, NY 10036  <b>STEVEN DAVID HARLACKER</b> CONNECTICUT PROFESSIONAL ENGINEER LICENSE NO. PEN.0022034 DATE: 08/04/2020			
REVISION	BY	C'K'D	DATE

**NATIONAL RAILROAD PASSENGER CORPORATION (AMTRAK)**

REPLACEMENT OF CONN. BRIDGE NO. 106.89  
 OVER THE CONNECTICUT RIVER  
 CONNECTICUT RIVER MP 3.4  
 TOWN OF OLD SAYBROOK, MIDDLESEX COUNTY &  
 TOWN OF OLD LYME, NEW LONDON COUNTY  
 STATE OF CONNECTICUT

CONSULTANT: HARDESTY & HANOVER LLC  
 APPLICATION BY:  
 NATIONAL RAILROAD PASSENGER CORPORATION  
 SHEET 5 OF 7

DATE: 08/04/2020

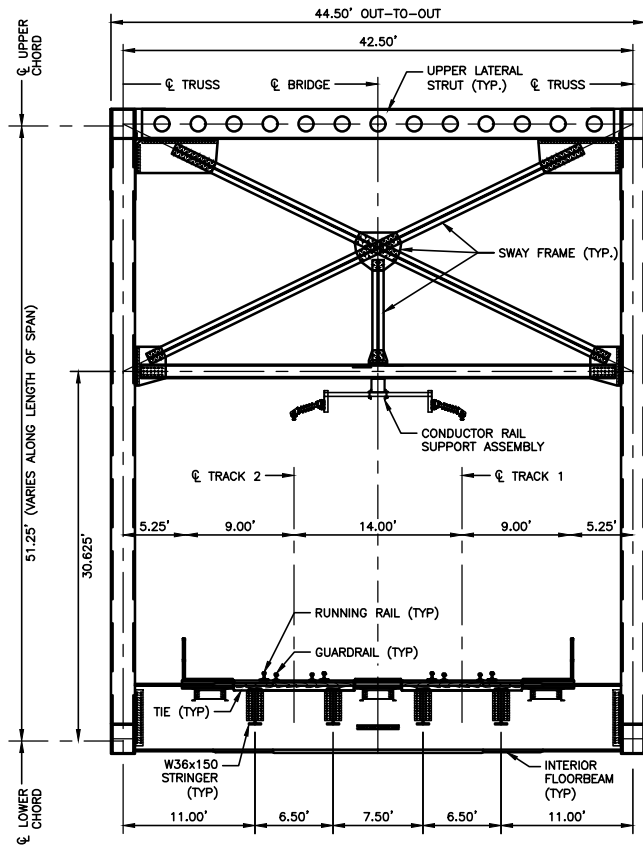

TYPICAL SECTION – BASCULE SPAN OVER NAVIGATION CHANNEL

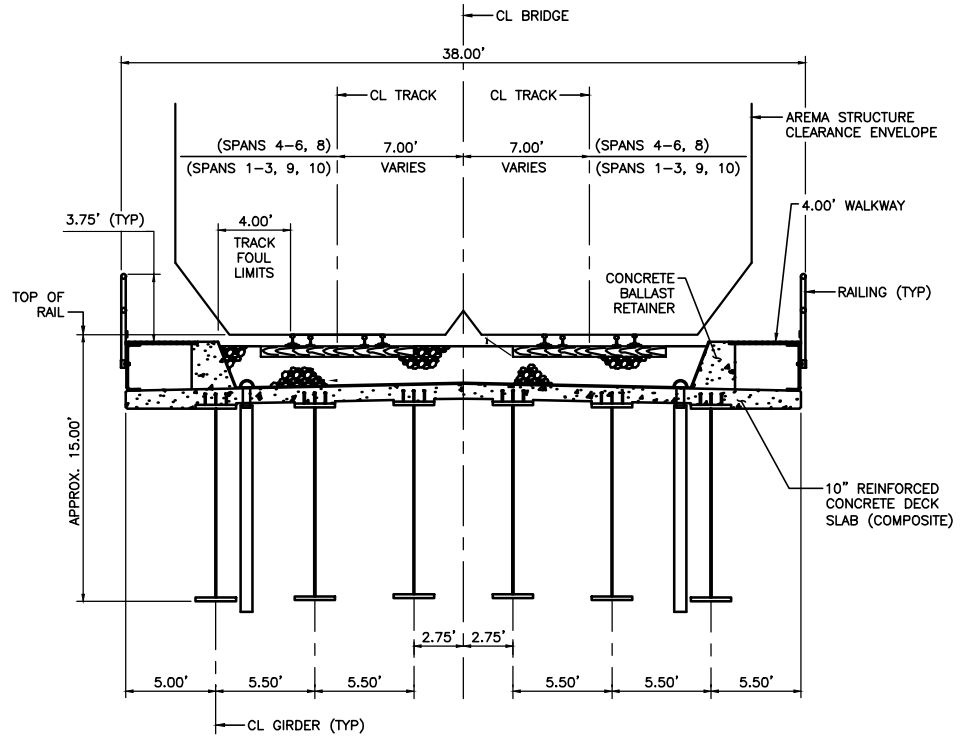
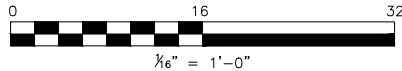

TYPICAL SECTION – APPROACH SPANS

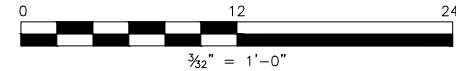

NOTES:

1. ALL BRIDGE ELEMENTS SHOWN ON THIS DRAWING REFLECT PROPOSED CONDITIONS.

MHW EL. = +1.71  
 MLW EL. = -1.48  
 100 YEAR FLOOD = +15.00  
 500 YEAR FLOOD = +15.90  
 DATUM: NAVD 1988



NOTE: CONCEPTUAL PLANS USED TO OBTAIN U.S. COAST GUARD BRIDGE PERMIT

HARDESTY & HANOVER, LLC  
 1501 BROADWAY, NEW YORK, NY 10036

*Steven D. Harlacker*  
 STEVEN DAVID HARLACKER  
 CONNECTICUT PROFESSIONAL ENGINEER  
 LICENSE NO. PEN.0022034  
 DATE: 08/04/2020

REVISION	BY	C'K'D	DATE

NATIONAL RAILROAD PASSENGER CORPORATION (AMTRAK)

REPLACEMENT OF CONN. BRIDGE NO. 106.89  
 OVER THE CONNECTICUT RIVER  
 CONNECTICUT RIVER MP 3.4  
 TOWN OF OLD SAYBROOK, MIDDLESEX COUNTY &  
 TOWN OF OLD LYME, NEW LONDON COUNTY  
 STATE OF CONNECTICUT

CONSULTANT: HARDESTY & HANOVER LLC  
 APPLICATION BY:  
 NATIONAL RAILROAD PASSENGER CORPORATION

SHEET 6 OF 7 DATE: 08/04/2020

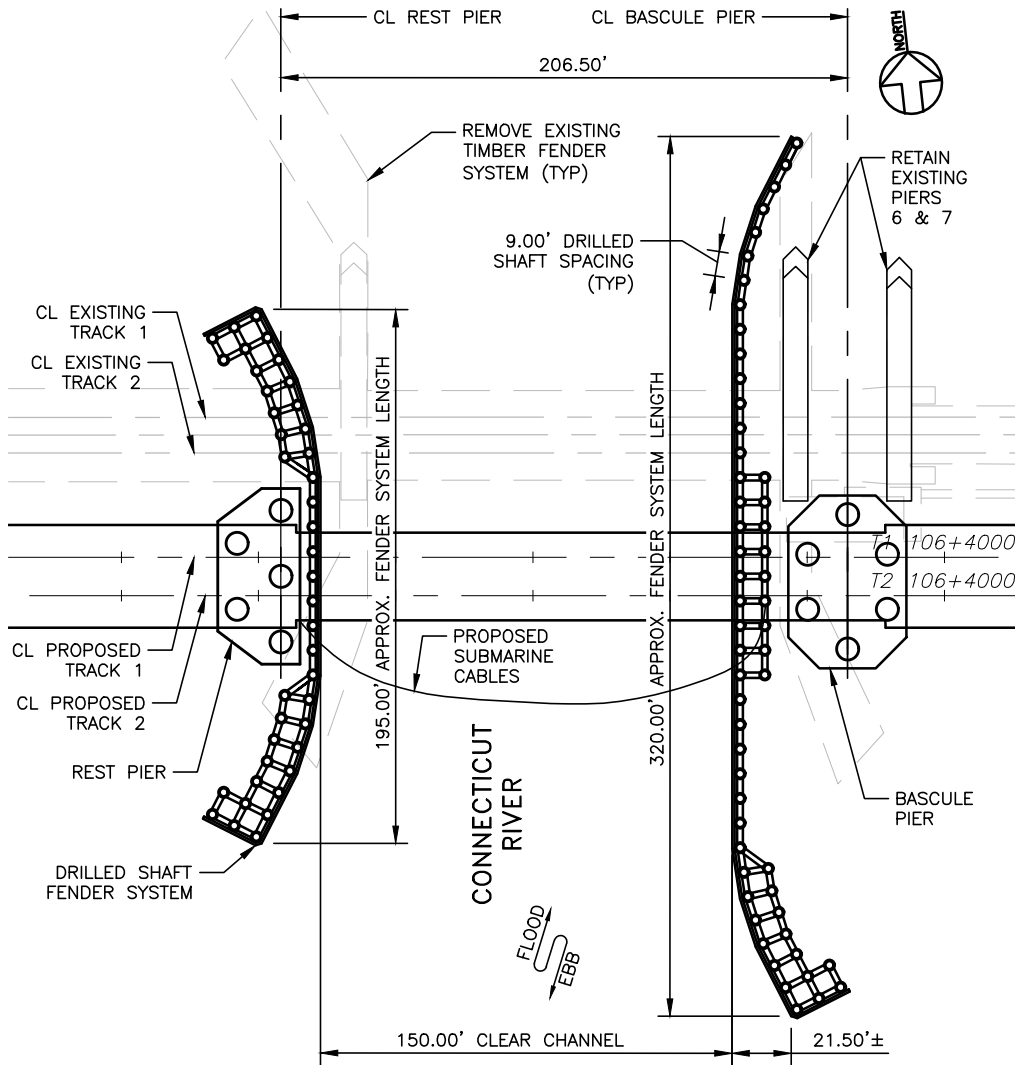

**BRIDGE PROTECTIVE SYSTEM (FENDER) PLAN**

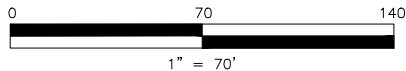

**NOTES:**

1. ALL ELEMENTS OF THE BRIDGE PROTECTIVE SYSTEM THAT MAY BE EXPOSED TO CHANNEL AND BOAT TRAFFIC, INCLUDING BUT NOT LIMITED TO COMPOSITE LUMBER WALES, PLASTIC LUMBER BLOCKING, PLASTIC LUMBER SUPPORTS, PLASTIC LUMBER RAILING, AND FIBERGLASS GRATING, SHALL BE FASTENED WITH COUNTERSUNK BOLTS.
2. UNLESS MARKED EXISTING, ALL ELEMENTS SHOWN ON THIS DRAWING REFLECT PROPOSED CONDITIONS.

MHW EL. = +1.71  
 MLW EL. = -1.48  
 100 YEAR FLOOD = +15.00  
 500 YEAR FLOOD = +15.90  
 DATUM: NAVD 1988

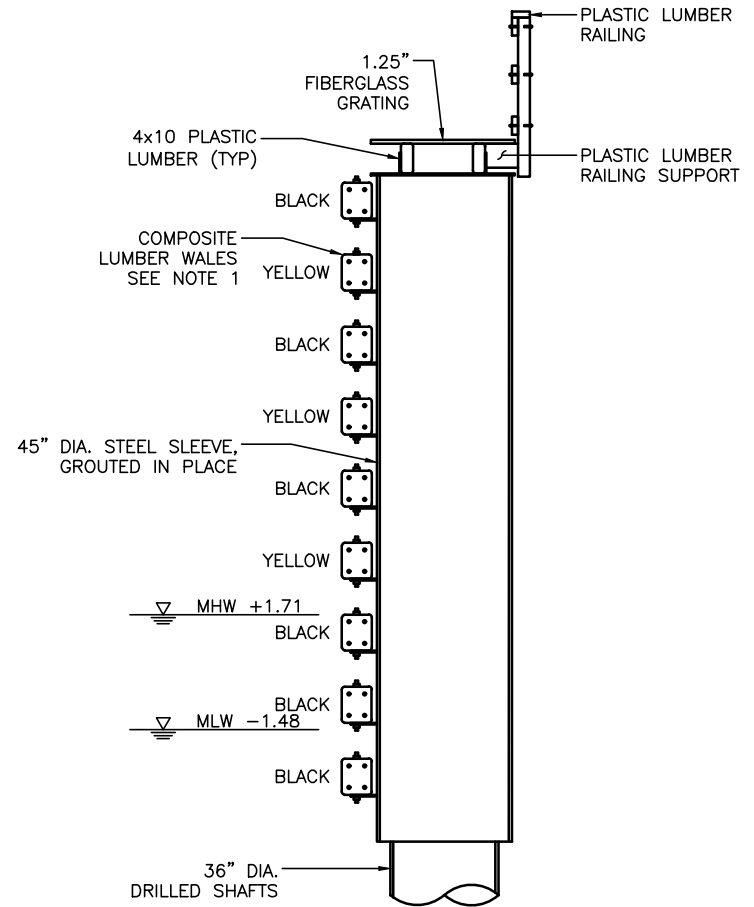

**FENDER TYPICAL SECTION**

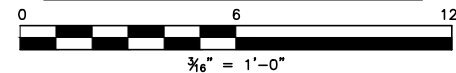

NOTE: CONCEPTUAL PLANS USED TO OBTAIN U.S. COAST GUARD BRIDGE PERMIT

HARDESTY & HANOVER, LLC  
 1501 BROADWAY, NEW YORK, NY 10036

STEVEN DAVID HARLACKER  
 CONNECTICUT PROFESSIONAL ENGINEER  
 LICENSE NO. PEN.0022034  
 DATE: 08/04/2020

**NATIONAL RAILROAD PASSENGER CORPORATION (AMTRAK)**

REPLACEMENT OF CONN. BRIDGE NO. 106.89  
 OVER THE CONNECTICUT RIVER  
 CONNECTICUT RIVER MP 3.4  
 TOWN OF OLD SAYBROOK, MIDDLESEX COUNTY &  
 TOWN OF OLD LYME, NEW LONDON COUNTY  
 STATE OF CONNECTICUT

CONSULTANT: HARDESTY & HANOVER LLC  
 APPLICATION BY:  
 NATIONAL RAILROAD PASSENGER CORPORATION

SHEET 7 OF 7

DATE: 08/04/2020

REVISION	BY	C'K'D	DATE